

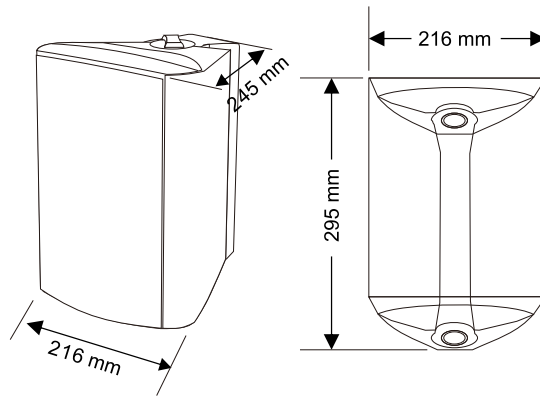

Active Wall Mount Speaker

T-776RSW



Model	T-776RSW (White)
Output Power	20W×2@8Ω
Input Sensitivity	0.7V
Frequency Response	80Hz-16KHz/1W, ±3dB
THD	1KHz/1W, 0.1%
S.N. Ratio	85dB
Conversion Rate	30V/US
Channel Degree of Separation	>65dB
Amplifier	D class
Indication	Power and channel signal
Protection	High temp, overload, short circuit and clip
Treble Control	±10dB
Bass Control	±10dB
Input Connector	Balanced phoenix connecto and stereo 3.5mm earphone input
RS232	Yes
VCA	Yes
Remote control	Infrared remote control
AC Power Supply	~110V-240V 50/60Hz
Dimensions	220 ×245 ×295mm
Weight	6.8Kg (per pair)